

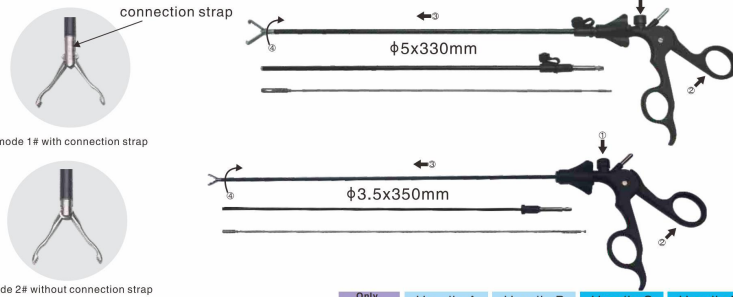













3mm&3.5mm&5mm Forceps



Tips	Code	Only Handle A/B				Handle A	Handle B	Handle C	Handle D
		3mm 300mm	5mm 330mm	5mm 440mm	3.5mm 350mm				
	S401-251	•	•	•	•				
	S401-253	•	•	•	•				
	S401-254	•	•	•					
	S401-256	•	•	•	•				
	S401-258	•	•	•					
	S401-259	•	•	•					
	S401-261	•	•	•	•				
	S401-262	•	•	•	•				
	S401-263	•	•	•	•				
	S401-262B	•	•	•	•				

3mm&3.5mm&5mm Forceps



Tips	Code	Only Handle A/B				Handle A	Handle B	Handle C	Handle D
		5mm 200mm	5mm 330mm	5mm 440mm	3.5mm 350mm				
	S401-264	•	•	•	•				
	S401-265	•	•	•	•				
	S401-262-2	•	•	•	•				
	S401-382	•	•	•	•				
	S401-266	•	•	•	•				
	S401-112	•	•	•	•				
	S401-113	•	•	•	•				
	S401-115	•	•	•	•				
	S401-271	•	•	•	•				
	S401-271.1	•	•	•	•				

3mm&3.5mm&5mm Forceps

Tips	Code	Only Handle A/B				Handle A	Handle B	Handle C	Handle D
		3mm 300mm	5mm 330mm	5mm 440mm	3.5mm 350mm				
	S401-271.2	•	•	•	•	•			
	S401-272B	•	•	•	•		•		•
	S401-272A	•	•	•			•		•
	S401-273	•	•	•	•		•		•
	S401-274	•	•	•	•		•		•
	S401-275	•	•	•	•		•		•
	S401-277	•	•	•	•		•		•
	S401-278	•	•	•	•		•		•
	S401-279	•	•	•	•		•		•
	S401-280	•	•	•	•		•		•
	S401-281	•	•	•	•		•		•
	S401-330	•	•	•			•		•
	S401-332A	•	•	•	•		•		•















3mm&3.5mm&5mm Forceps

Tips	Code	Only Handle A/B				Handle A	Handle B	Handle C	Handle D
		3mm 300mm	5mm 330mm	5mm 440mm	3.5mm 350mm				
	S401-332B	•	•	•			•		•
	S401-333	•	•	•	•		•		•
	S401-334	•	•	•	•		•		•
	S401-335-2	•	•	•	•		•		•
	S401-335	•	•	•	•		•		•
	S401-336	•	•	•	•		•		•
	S401-337	•	•	•	•		•		•
	S401-338	•	•	•	•		•		•
	S401-339	•	•	•	•		•		•
	S401-278-2	•	•	•	•		•		•
	S401-281-2	•	•	•	•		•		•
	S401-385	•	•	•		•		•	
	S401-386	•	•	•	•		•		•





3mm&3.5mm&5mm Forceps

Tips	Code	Tip Size				Handle A	Handle B	Handle C	Handle D
		3mm 300mm	5mm 330mm	5mm 440mm	3.5mm 350mm <small>Only Handle A/B</small>				
 25mm	S401-387	•	•	•	•	•		•	
 25mm	S401-388	•	•	•		•		•	
 26mm	S401-411	•	•	•		•		•	
 28mm	S401-397	•	•	•		•		•	
 28mm	S401-398	•	•	•		•		•	
 38mm	S401-276	•	•	•		•		•	
 25mm	S401-390	•	•	•		•		•	
 30mm	S401-392	•	•	•		•		•	
 10mm	S401-393	•	•	•	•		•		
 22mm	S401-394	•	•	•	•		•		
 33mm	S401-284-1	•	•	•		•		•	
 28mm	S401-395	•	•	•		•		•	
 28mm	S401-396	•	•	•		•		•	

10mm Forceps





Tips	Code	Tip Size		Handle E	Handle F	Handle G	Handle H	Handle I
		10mm 250mm	10mm 330mm					
	S401-368	•	•	•				
	S401-367	•	•	•				
	S401-367.2	•	•	•				
	S401-286	•	•		•			
	S401-297	•	•		•			
	S401-277-1	•	•		•			
	S401-381	•	•		•			
	S401-283	•	•		•			
	S401-276-2	•	•		•			
	S401-276-1	•	•		•			
	S401-273-1	•	•		•			
	S401-399		•		•			
	S401-284	•	•		•			
	S401-332C	•	•		•			
	S401-368.1	•	•	•				

10mm Forceps



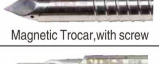

Tips	Code	10mm 250mm	10mm 330mm	Handle E	Handle F	Handle G	Handle H	Handle I
	S401-282	•	•	•	•			
	S401-105	•	•			•		
	S401-334-1	•	•					•
	S301-111	•	•		•			
	S301-S-11-1	•	•		•			
	S401-376-2		•					•
	S302-293		•					•
	S401-298		•					•
	S401-276-3	•	•		•			
	S401-279-2	•	•		•			
	S401-383	•	•	•				
	S401-384	•	•	•				
	S401-282.2	•	•		•			
	S401-367.2	•	•	•				
	S401-367.3	•	•	•				

Trocar



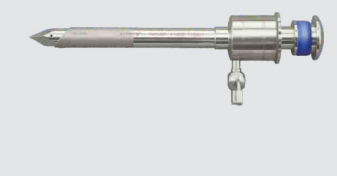

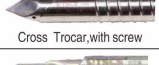
Trocar, magnetic

		S401-619.1 ϕ 3.5x95mm S401-619.2 ϕ 5.5x95mm S401-619.3 ϕ 10.5x95mm S401-619.4 ϕ 13x95mm
		S401-605.1 ϕ 5.5x95mm S401-605.2 ϕ 10.5x95mm S401-605.3 ϕ 13x95mm
		S401-621.1 ϕ 5.5x95mm S401-621.2 ϕ 10.5x95mm S401-621.3 ϕ 13x95mm
		S401-617.1 ϕ 5.5x95mm S401-617.2 ϕ 10.5x95mm S401-617.3 ϕ 13x95mm

Trocar, cross

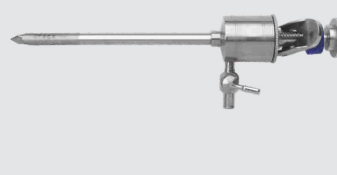
		S401-611.1 ϕ 3.5x95mm S401-611.2 ϕ 5.5x95mm S401-611.3 ϕ 10.5x95mm S401-611.4 ϕ 13x95mm
		S401-614.1 ϕ 5.5x95mm S401-614.2 ϕ 10.5x95mm S401-614.3 ϕ 13x95mm
		S401-603.1 ϕ 5.5x95mm S401-603.2 ϕ 10.5x95mm S401-603.3 ϕ 13x95mm
		S401-618.1 ϕ 5.5x95mm S401-618.2 ϕ 10.5x95mm S401-618.3 ϕ 13x95mm

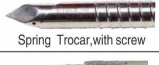
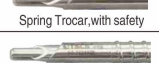
Trocar, spring

		S401-615.2 ϕ 5.5x95mm S401-615.3 ϕ 10.5x95mm S401-615.4 ϕ 13x95mm
		S401-623.1 ϕ 5.5x95mm S401-623.2 ϕ 10.5x95mm S401-623.3 ϕ 13x95mm
		S401-616.1 ϕ 5.5x95mm S401-616.2 ϕ 10.5x95mm S401-616.3 ϕ 13x95mm
		S401-624.1 ϕ 5.5x95mm S401-624.2 ϕ 10.5x95mm S401-624.3 ϕ 13x95mm

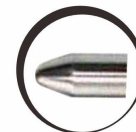

Conical Tips, Blunt



Conical Tips, Sharp

TSCS also offer you Trocars with Conical Tips. Blunt and Conical Tips. Sharp as your needed.

Reducer

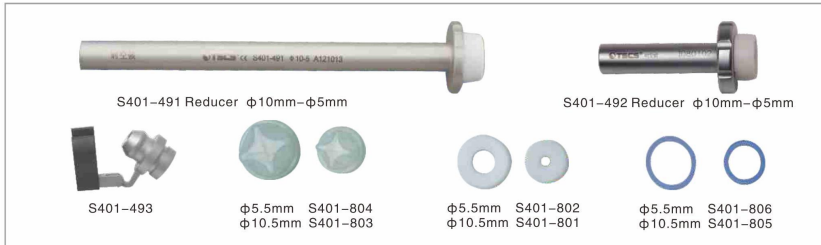

Small Incision Surgical Instruments

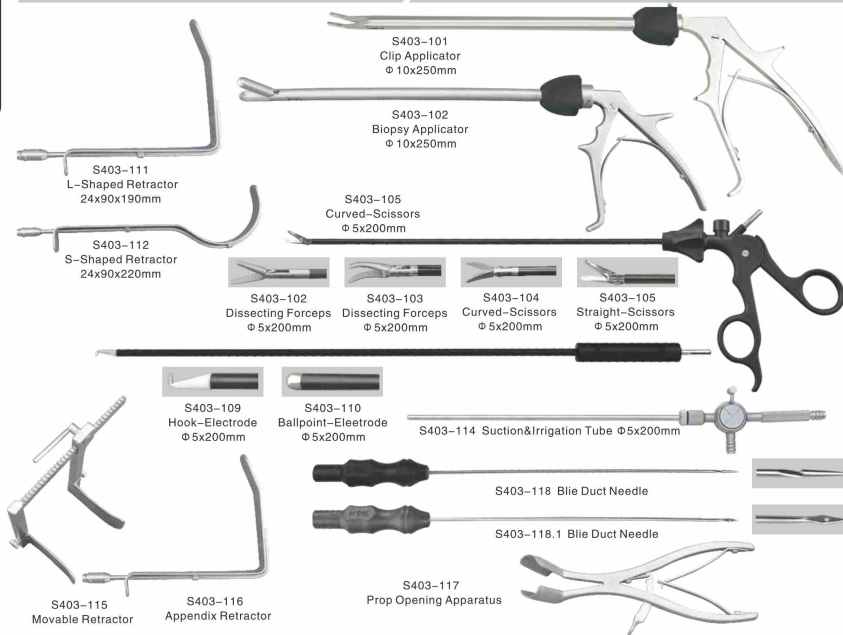

Bile duct puncture needle

- S401-285 Tips $\phi 0.8\text{mm}$
- S401-285.1 Tips $\phi 1.0\text{mm}$
- S401-285.2 Tips $\phi 1.2\text{mm}$
- S401-285.3 Tips $\phi 1.5\text{mm}$
- S401-285.4 Tips $\phi 1.8\text{mm}$
- S401-285.5 Tips $\phi 2.0\text{mm}$
- S401-285.6 Tips $\phi 2.2\text{mm}$



Needle holder

Mode O $\phi 5 \times 330\text{mm}$

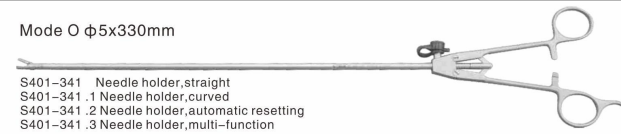

- S401-341 Needle holder, straight
- S401-341.1 Needle holder, curved
- S401-341.2 Needle holder, automatic resetting
- S401-341.3 Needle holder, multi-function

Mode V $\phi 5 \times 330\text{mm}$



- S401-342 Needle holder, straight
- S401-342.1 Needle holder, curved
- S401-342.2 Needle holder, automatic resetting
- S401-342.3 Needle holder, multi-function

Mode V1 $\phi 5 \times 330\text{mm}$



- S401-343 Needle holder, straight
- S401-343.1 Needle holder, curved
- S401-343.2 Needle holder, automatic resetting
- S401-343.3 Needle holder, multi-function

Mode V2 $\phi 5 \times 330\text{mm}$



- S401-344 Needle holder, straight
- S401-344.1 Needle holder, curved
- S401-344.2 Needle holder, automatic resetting
- S401-344.3 Needle holder, multi-function

Mode Pistol $\phi 5 \times 330\text{mm}$



- S401-345 Needle holder, straight
- S401-345.1 Needle holder, curved
- S401-345.2 Needle holder, automatic resetting
- S401-345.3 Needle holder, multi-function

Mode A $\phi 5 \times 330\text{mm}$



- S401-346 Needle holder, straight
- S401-346.1 Needle holder, curved
- S401-346.2 Needle holder, automatic resetting
- S401-346.3 Needle holder, multi-function



Clip Applicator

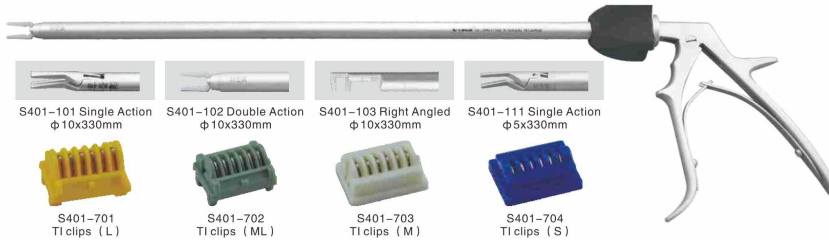

Hem-o-lok

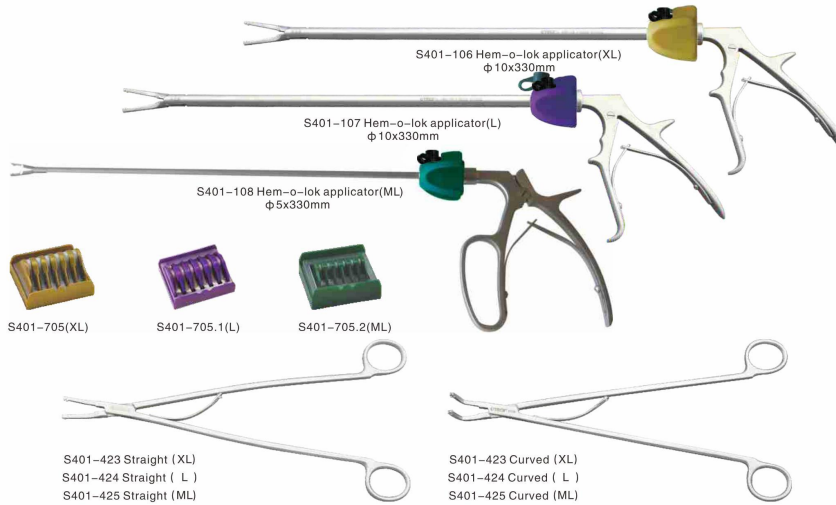

Clip Remover



Clip Applicator

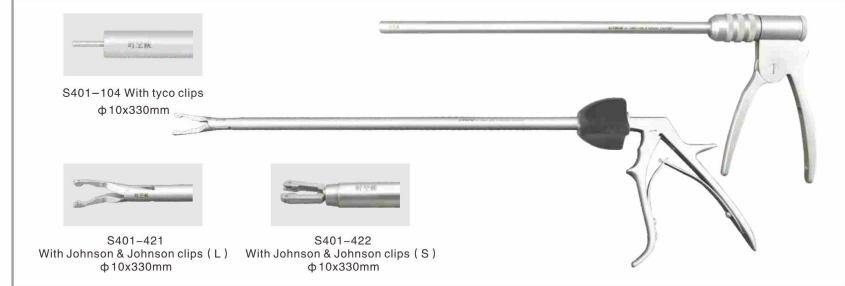

Bulldog Forceps

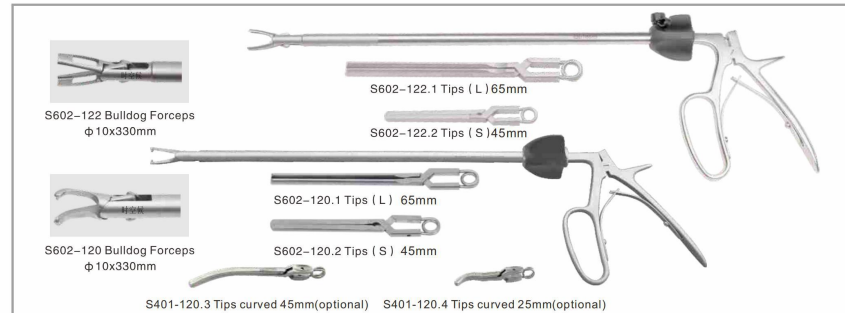

Veress Needle



Spring forceps



Articulating Instruments

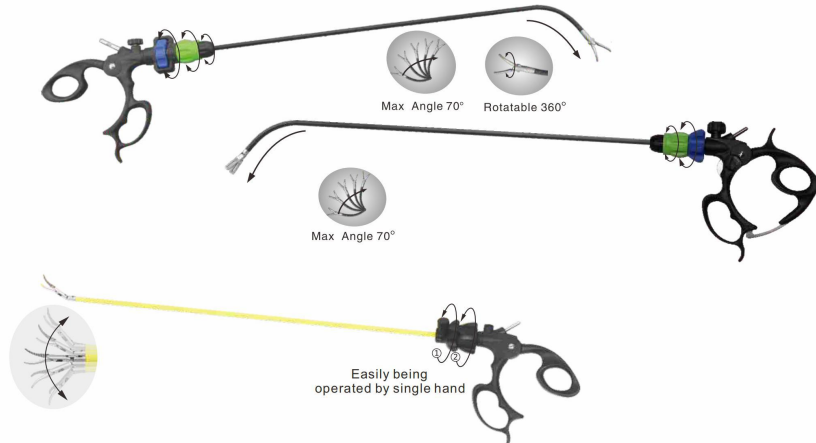

Monopolar forceps & scissors

Tips	Code	5mm 400mm	Single 360°	Double 360°	Handle S	Handle A	Handle B	Handle C	Handle D
	S407-256	•	•	•	•	•	•	•	•
	S407-262	•	•	•	•	•	•	•	•
	S407-264	•	•	•	•	•	•	•	•
	S407-281	•	•	•	•	•	•	•	•
	S407-280	•	•	•	•	•	•	•	•
	S407-275	•	•	•	•	•	•	•	•
	S407-265	•	•	•	•	•	•	•	•
	S407-271	•	•	•	•	•	•	•	•
	S407-398	•	•	•	•	•	•	•	•
	S407-336	•	•	•	•	•	•	•	•

Articulating Electrodes

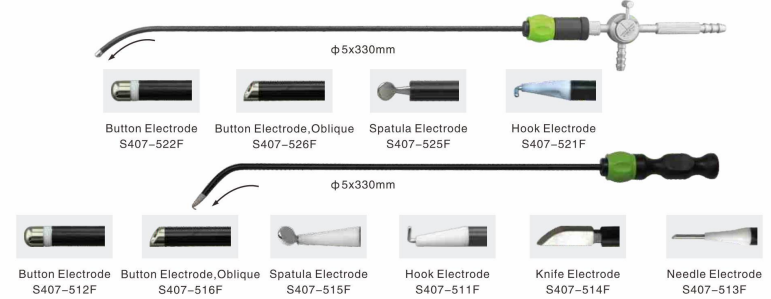

Bipolar Articulating Coagulation Forceps

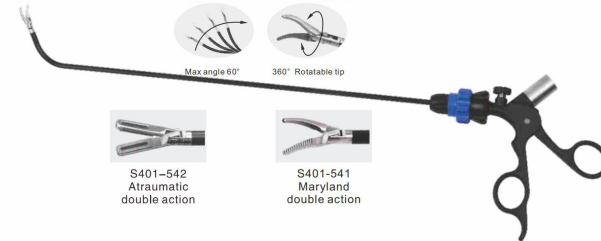

Bipolar Coagulation Forceps

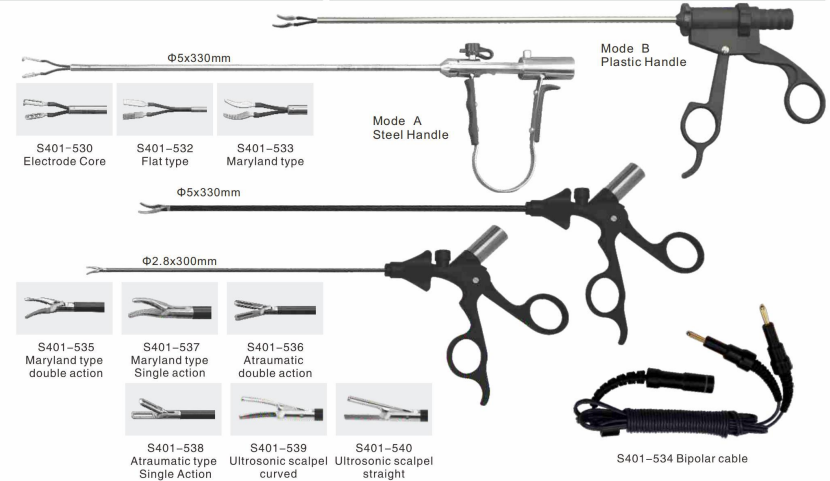

Monopolar Electrode

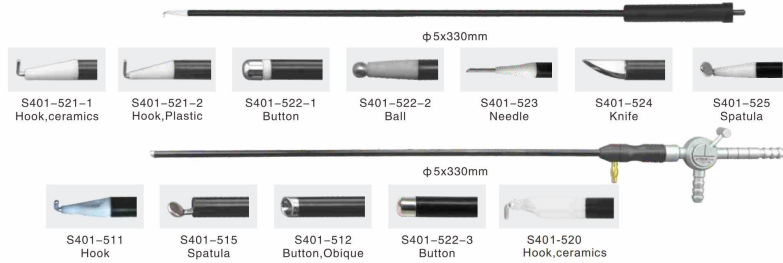

Monopolar cable

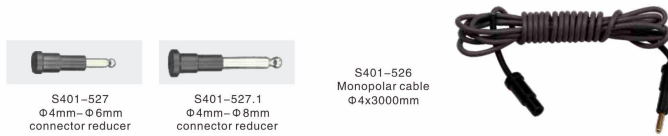

Cholangiography Forceps



Stone Forceps For bile Duct

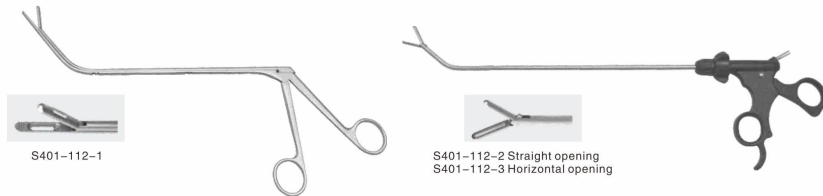

Bile Duct Knife



Hernia Repair Instrument

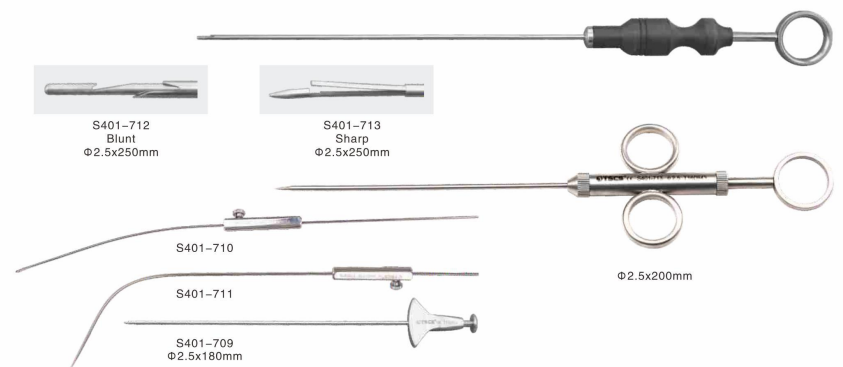

Golden Finger

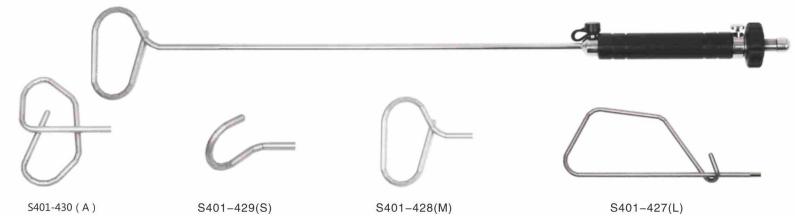

Suction&irrigation Tube



Ligature Probe

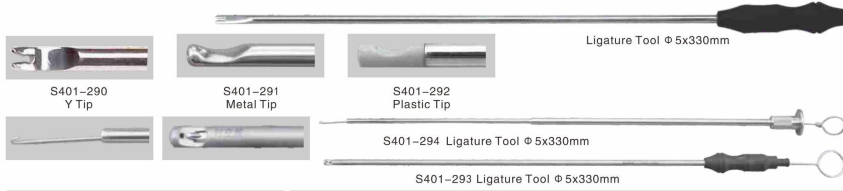

Single Port Laparoscopy

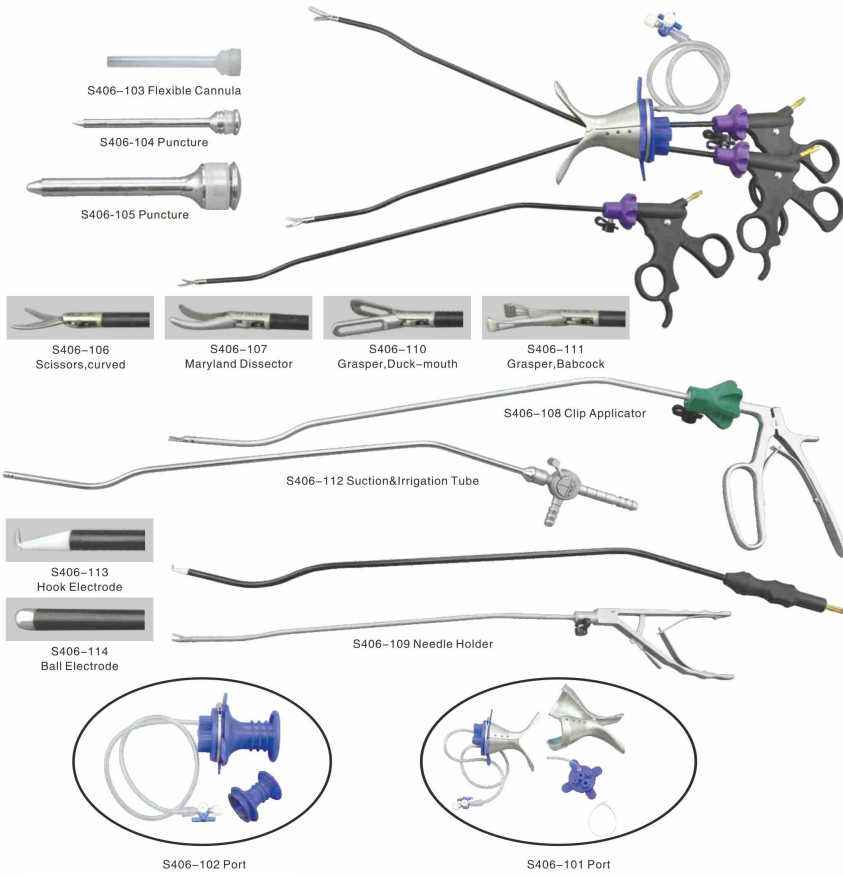

Pediatric Laparoscopy Instrument

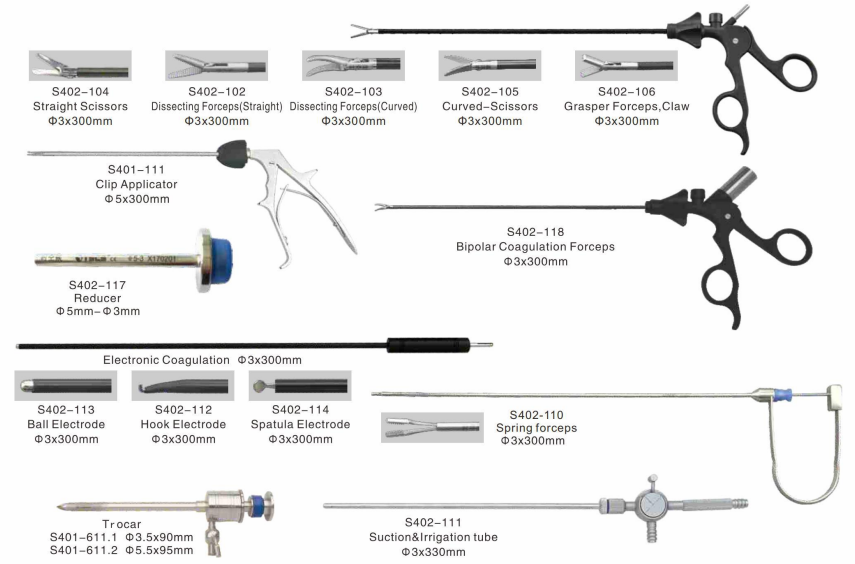

Fan-Shaped Forcep



Articulating Disposable Instruments

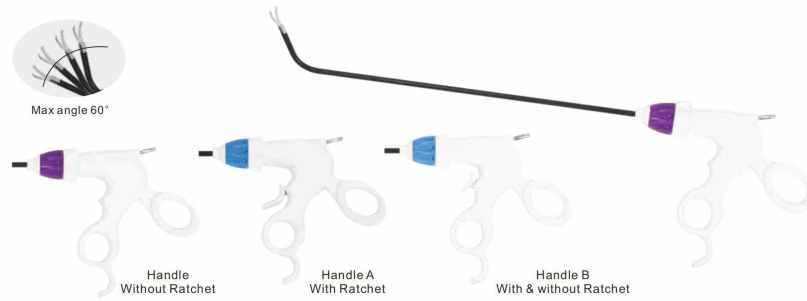

	S408-256F Scissors Double action Φ5x330mm		S408-264F Maryland short, double action Φ5x330mm
	S408-262F Maryland Double action Φ5x330mm		S408-270.1F Graspers Claw forceps Φ5x330mm
	S408-281F Graspers Atraumatic forceps Φ5x330mm		S408-398F Graspers Allis Forceps Φ5x330mm
	S408-280F Graspers Atraumatic forceps Φ5x330mm		S408-336F Graspers Bowel graspers Φ5x330mm
	S408-275F Graspers Babcock forceps Φ5x330mm		S408-265F Dissectors Mixer Φ5x330mm

Disposable Instruments

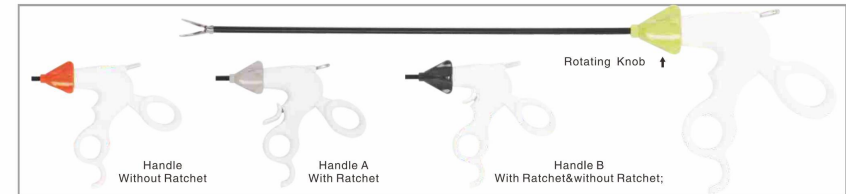

	S408-256 Scissors Double action Φ5x330mm		S408-257 Scissors High insulation Φ5x330mm
	S408-262 Maryland Double action Φ5x330mm		S408-271.1 Graspers Claw forceps Φ5x330mm
	S408-281 Graspers Atraumatic forceps Φ5x330mm		S408-398 Graspers Allis forceps Φ5x330mm
	S408-280 Graspers Atraumatic forceps Φ5x330mm		S408-336 Graspers Bowel forceps Φ5x330mm
	S408-275 Graspers Babcock forceps Φ5x330mm		S408-265 Dissectors Mixer Φ5x330mm

Disposable Electrode



Disposable Bipolar Coagulation Forceps

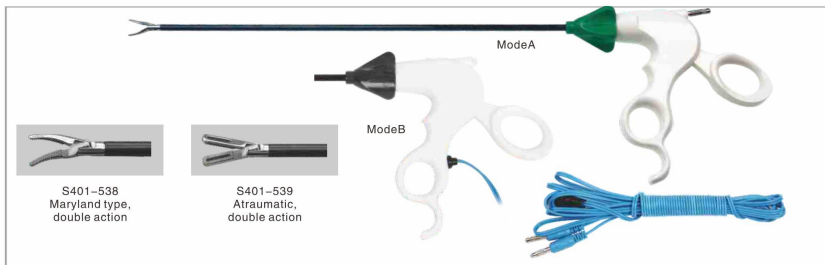

S401-538 Maryland type, double action

S401-539 Atraumatic double action

Reusable

Disposable shaft with reusable handle
Perfect compatible
Very economical



	S408-256R Scissor Double action Φ5x330mm		S408-264R Dissector Maryland forceps Φ5x330mm
	S408-262R Dissector Maryland forceps Φ5x330mm		S408-271.1R Graspers Claw forceps 3+2 Φ5x330mm
	S408-281R Graspers Atraumatic forceps Φ5x330mm		S408-398R Graspers Alis forceps Φ5x330mm
	S408-280R Graspers Clinch forceps Φ5x330mm		S408-336R Graspers Bowel forceps Φ5x330mm
	S408-275R Graspers Babcock forceps Φ5x330mm		S408-265R Dissectors Mixer Φ5x330mm

Disposable Retrieval Bag

Order Code	Volume
S408-230	100ml
S408-230-1	200ml
S408-230-2	400ml
S408-230-3	700ml



Ergonomic handle design, push-pull operation comfort, easy in, easy out, easy open, easy close, save time.

TPU high strength medical bags, transparent soft; NI-TI open device, fully open, when removed, automatically tighten the bag, to prevent overflow.

Disposable Trocar

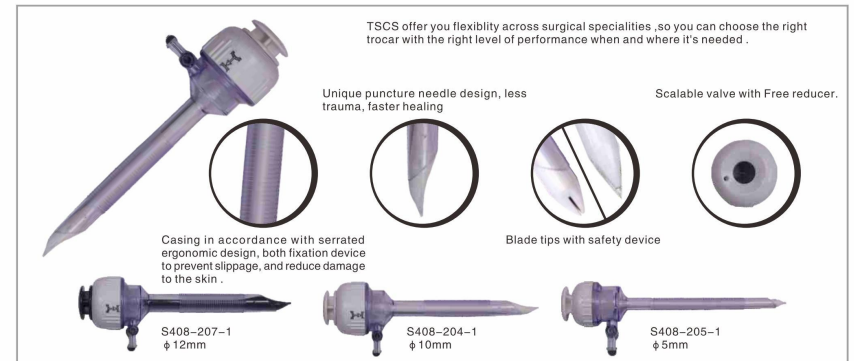

TSCS offer you flexibility across surgical specialties, so you can choose the right trocar with the right level of performance when and where it's needed.

Unique puncture needle design, less trauma, faster healing

Scalable valve with Free reducer.

Casing in accordance with serrated ergonomic design, both fixation device to prevent slippage, and reduce damage to the skin.

Blade tips with safety device

S408-207-1
Φ12mm

S408-204-1
Φ10mm

S408-205-1
Φ5mm

Direct visualisation eliminates blind entry by enabling visualisation of tissue layers during insertion and multiple needle tips for choose.

S408-212-2
Visible sleeve Φ12mm

Bladeless Trocar

Safety Trocar

Visible Trocar

Product Code	Shaft Diameter	Shaft Length	Sleeve
S408-213	Φ3mm	112mm	bladeless
S408-205	Φ5mm	112mm	bladeless
S408-210	Φ10mm	112mm	bladeless
S408-212	Φ12mm	112mm	bladeless
Product Code	Shaft Diameter	Shaft Length	Sleeve
S408-213-1	Φ3mm	112mm	Blade with safety
S408-205-1	Φ5mm	112mm	Blade with safety
S408-210-1	Φ10mm	112mm	Blade with safety
S408-212-1	Φ12mm	112mm	Blade with safety
Product Code	Shaft Diameter	Shaft Length	Sleeve
S408-212-2	Φ12mm	112mm	Visible

Disposable suction&irrigation tube



Disposable veress needle



Disposable Aspiration needle



Disposable Retractor Rings

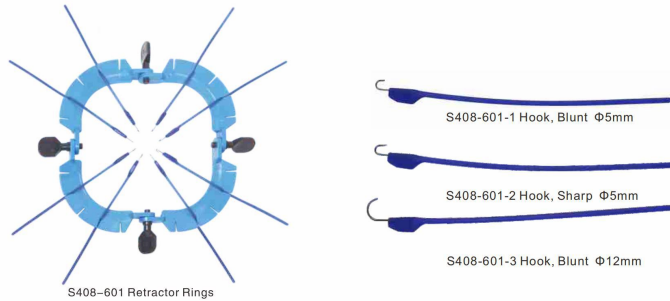

Disposable Single-port Access



Disposable Uterine Manipulator

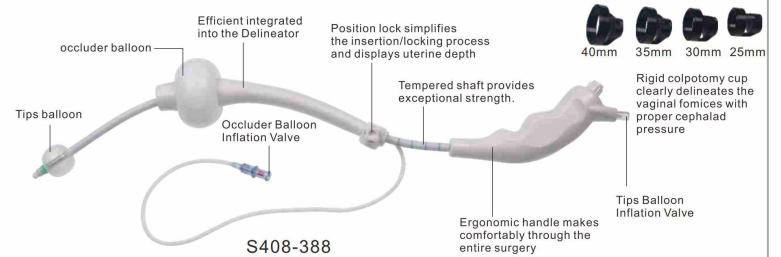

Nerve Probe Forceps

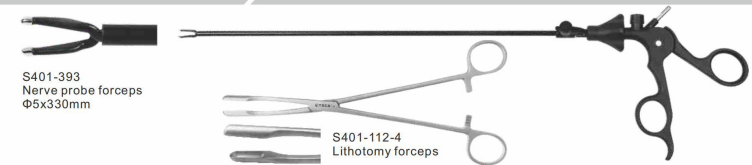

Special Vaginal Retractor(Suture Needle)



Instruments for Hysterectomy surgery



Multifunctional Uterus Apparatus

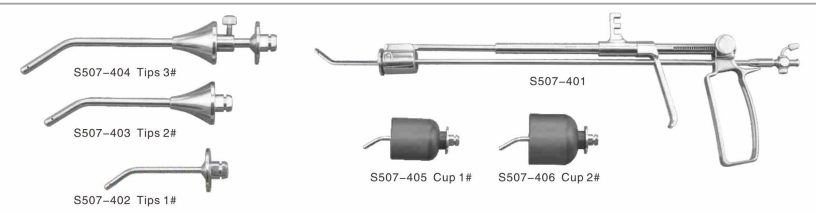

Combined Multifunctional Uterus Apparatus

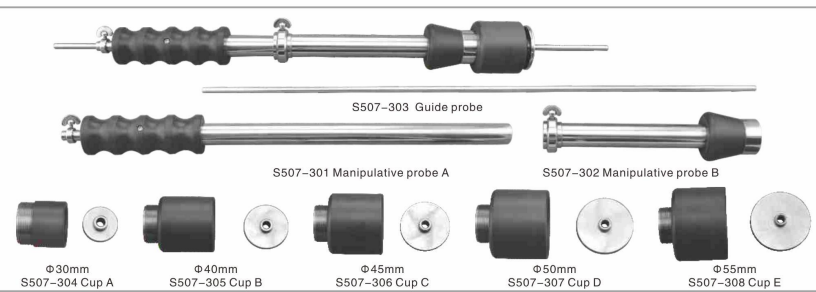

NEW Uterus Apparatus



Uterus Apparatus



Uterus Apparatus A

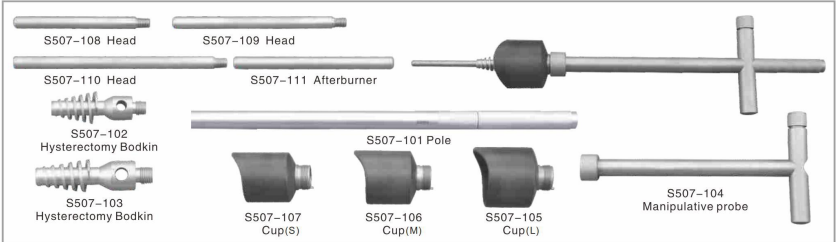

Uterus Apparatus B

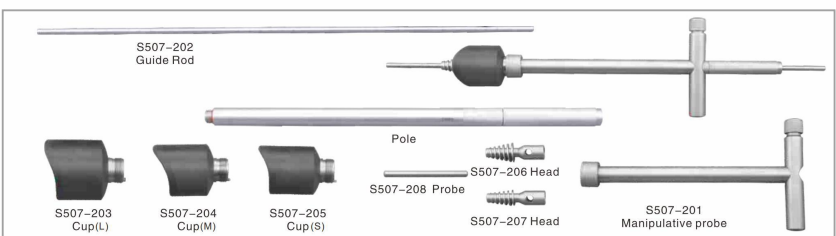

Gynecological Forceps

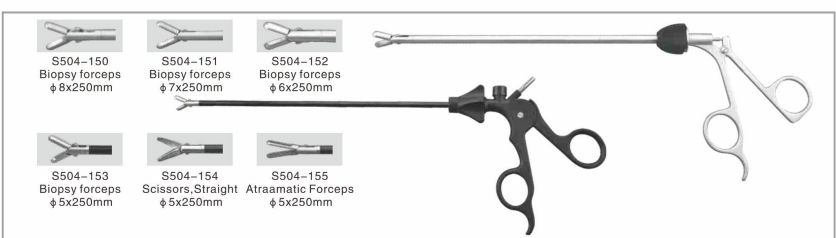

Forceps

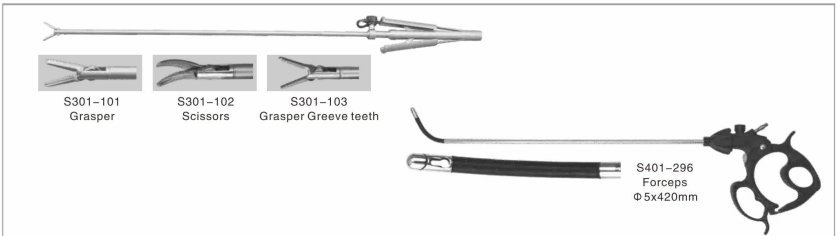

Hysteroscopy(Operation)

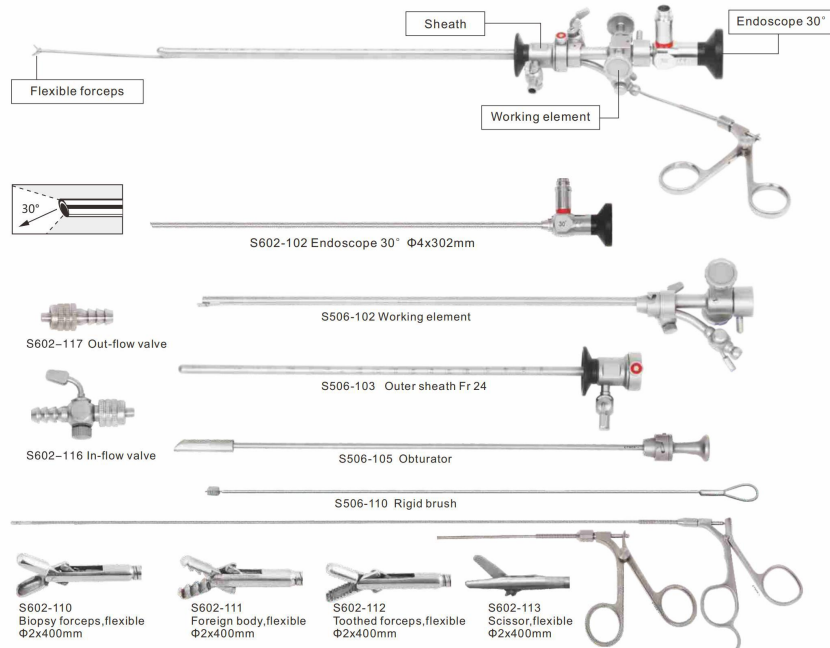

Hysteroscopy(Diagnostic)

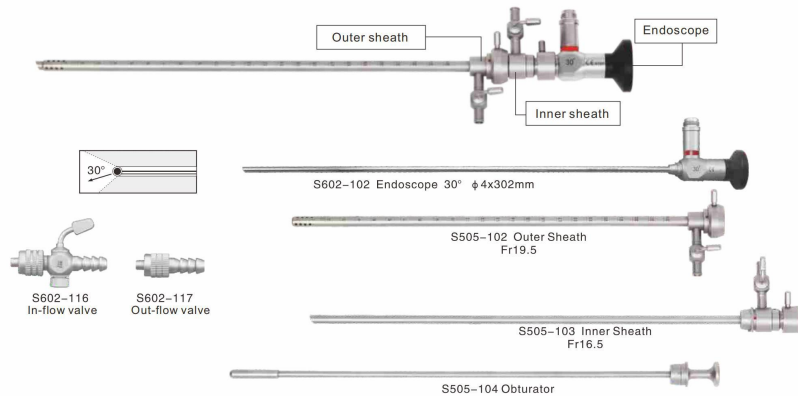

Hysteroscopy(Operation)

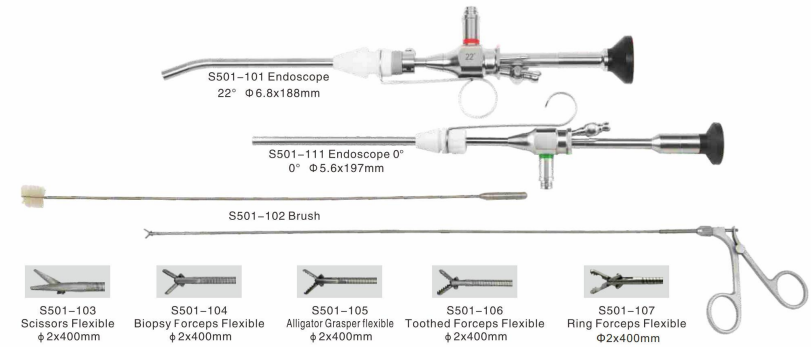

Hysteroscopes

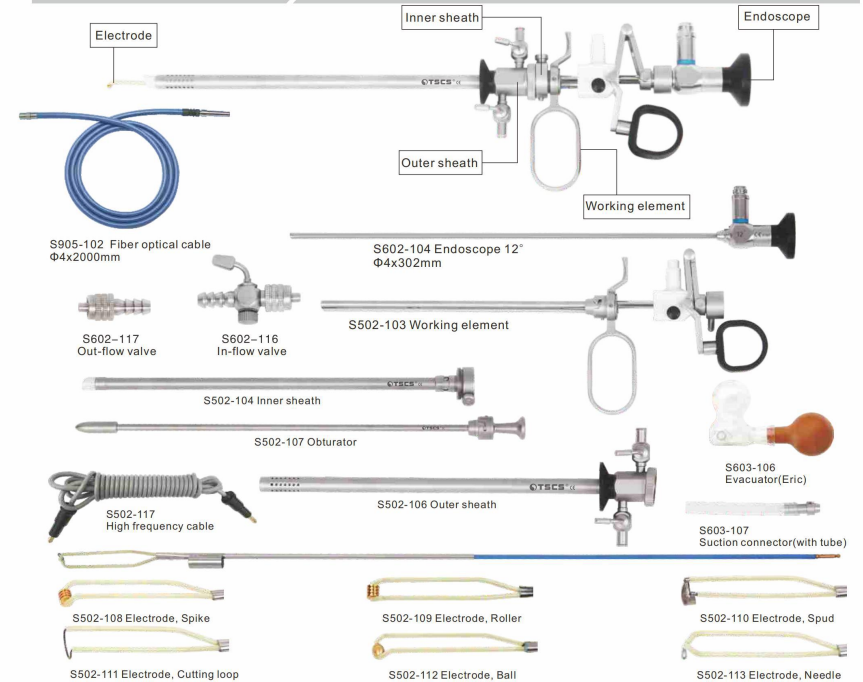

Hysteroscopy Operation 2.9mm (quick lock type)

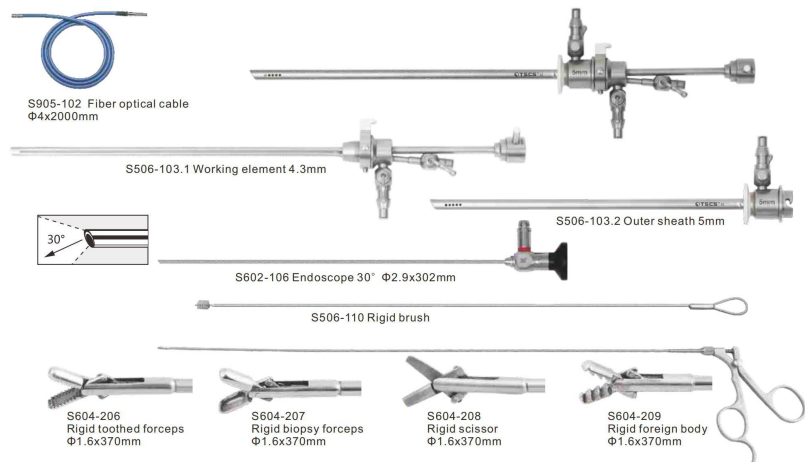

Hysteroscopy Operation 4mm (quick lock type)

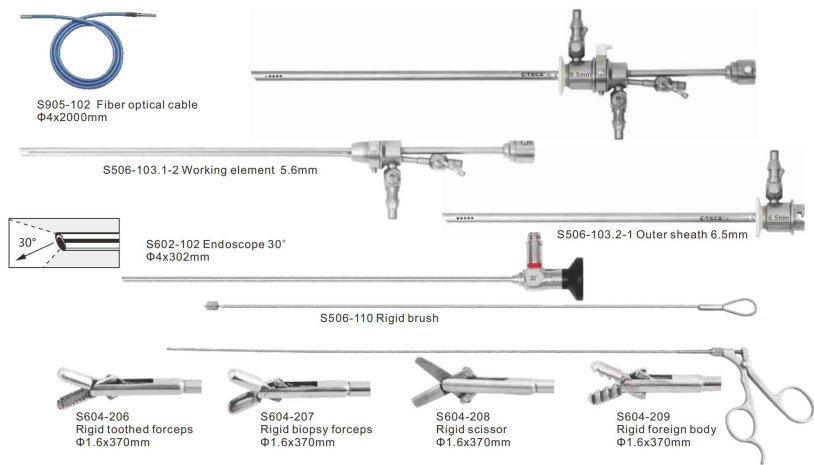

Hysteroscopy 2.9mm(Operation)

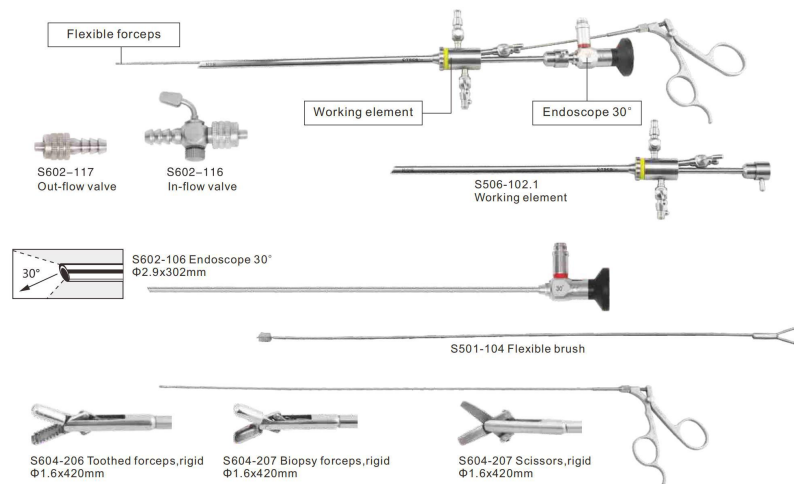

Hysteroscopy 4mm(Operation)

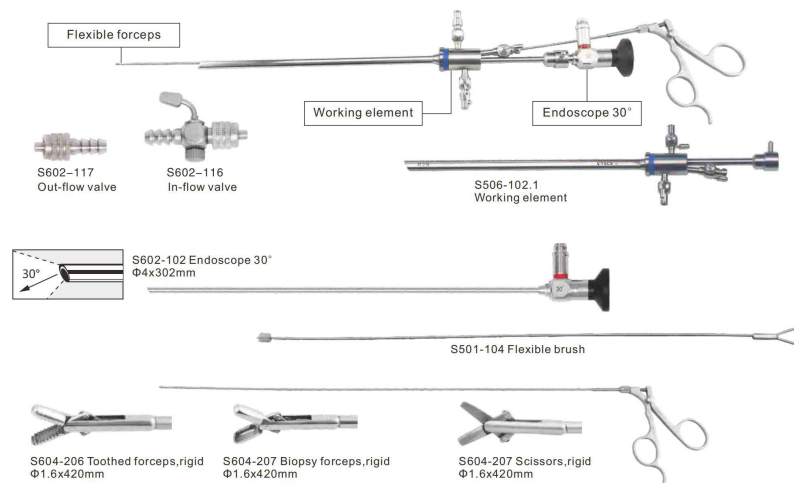

Morcellator

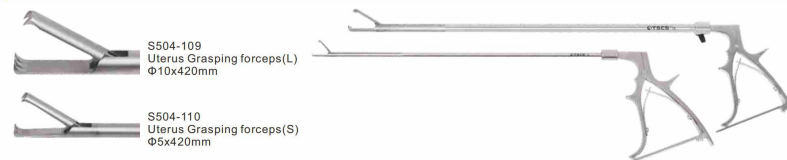
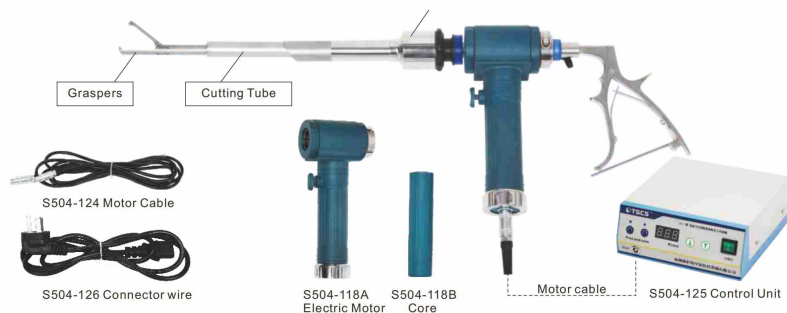

Optional

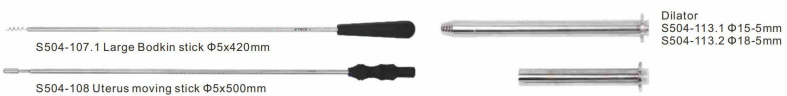

Morcellator(continuous resection)

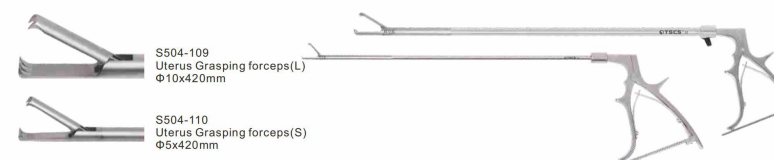
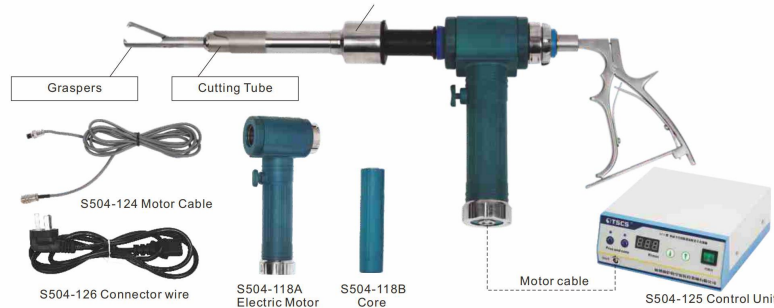

Instruments For Thoracoscopic Surgery

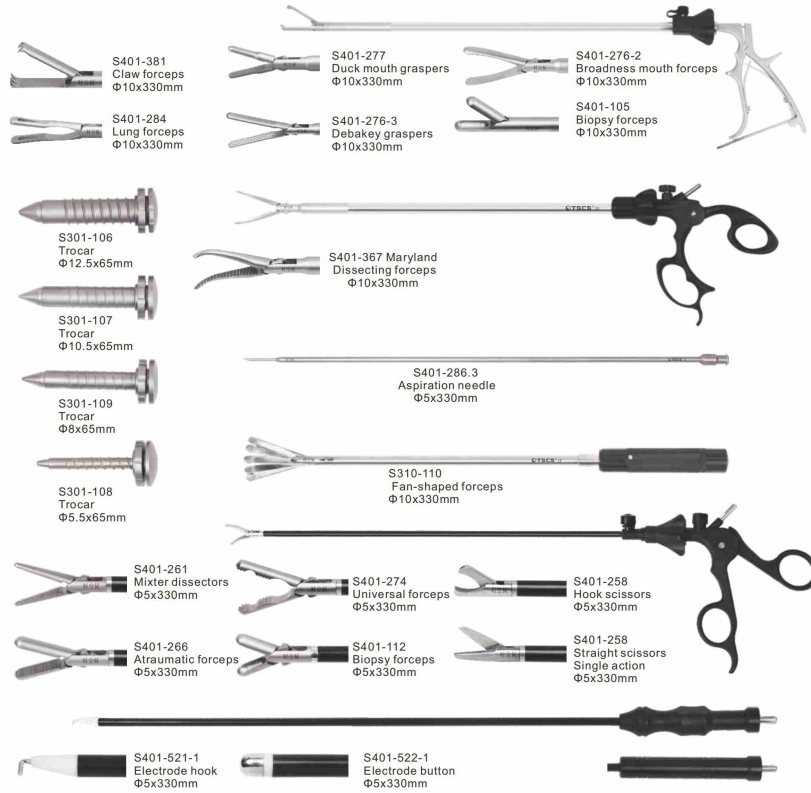

Optional

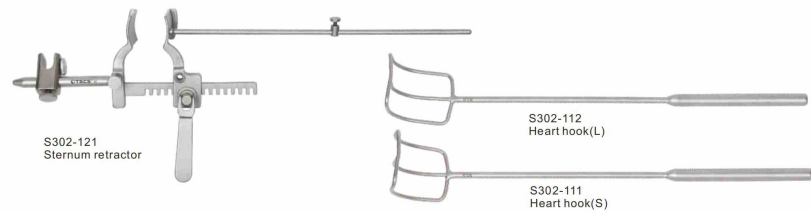

Instruments for Thoracoscopic Surgery

Double Joints

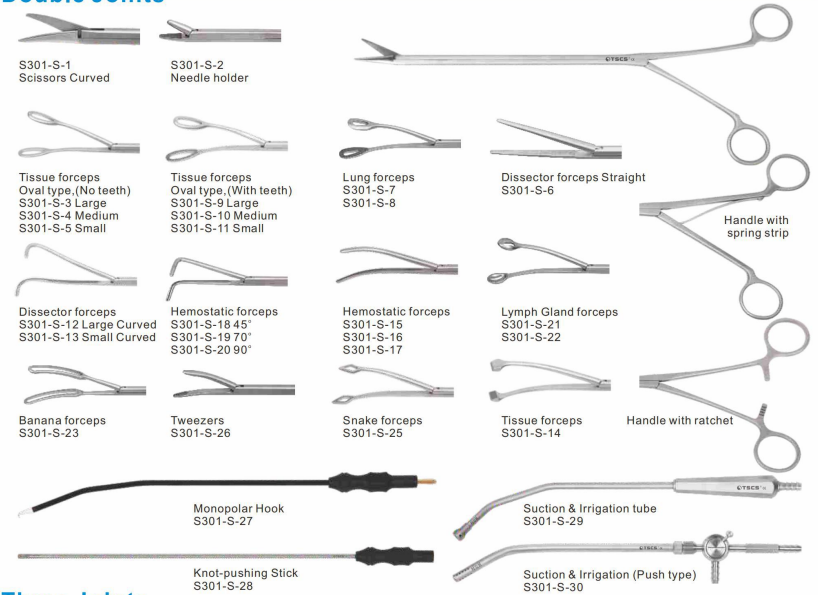

Three Joints



Single Joints

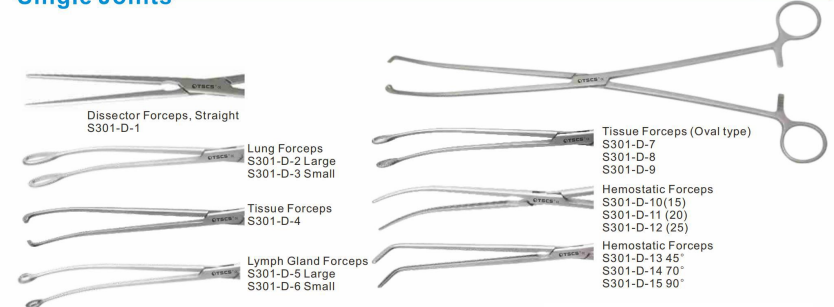

Sinoscope

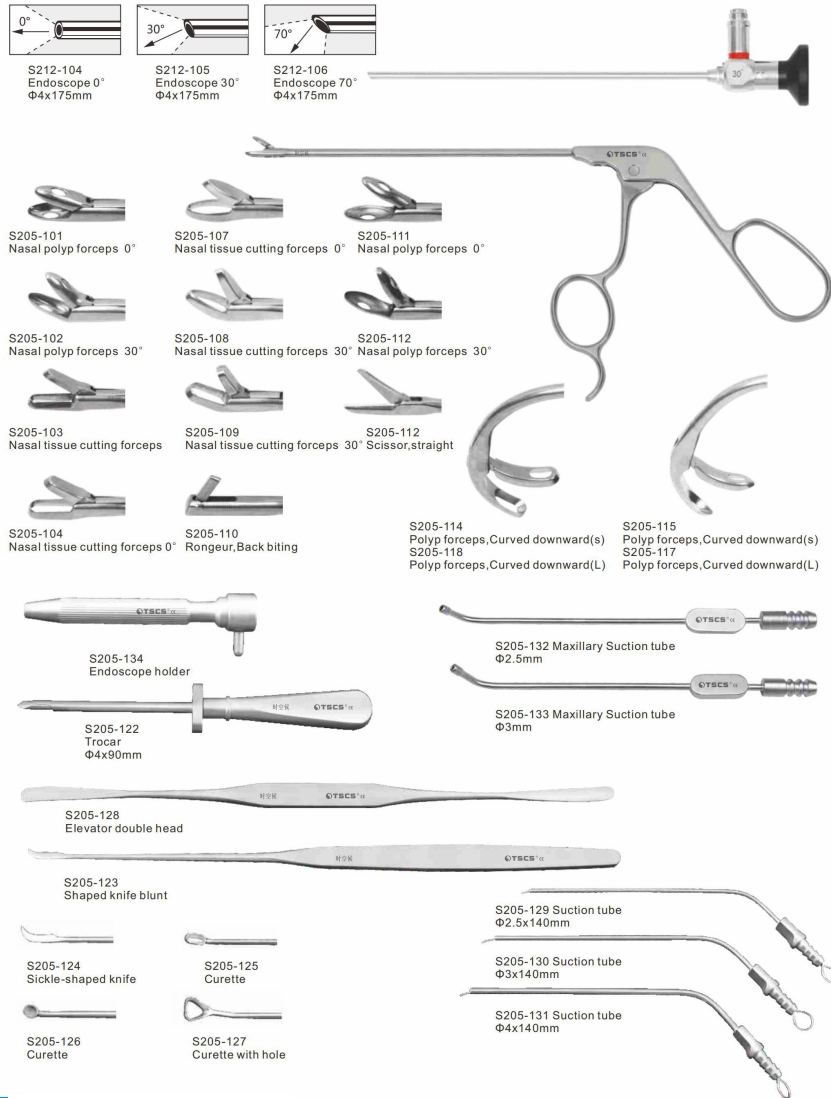

Pedestal Laryngoscope



Optional

Otoscope Instrument

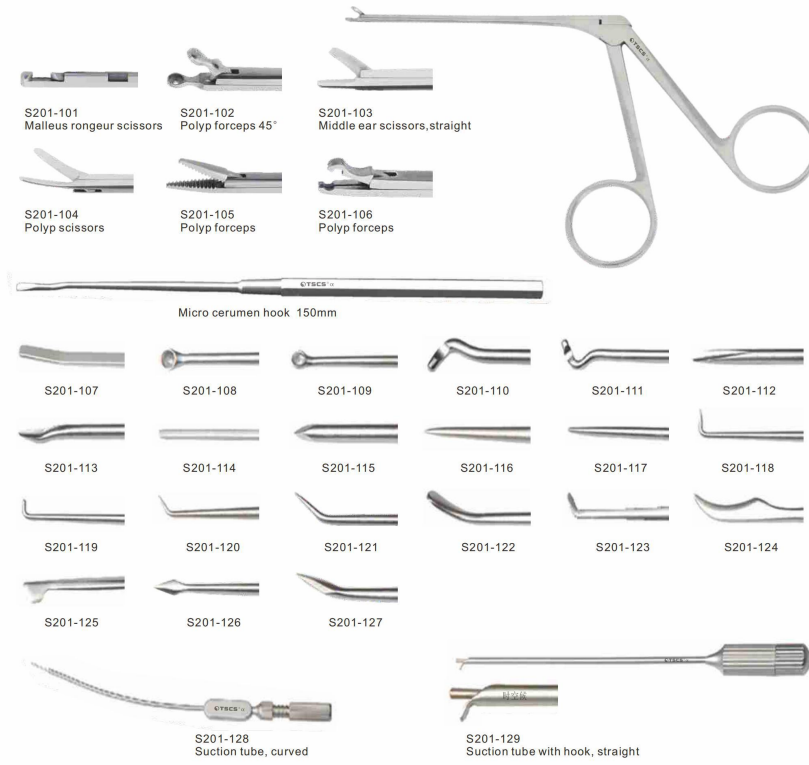

Shaver (For ENT)



Bronchoscopy

S207-101 Bronchoscope ϕ 6x280mm
S207-102 Bronchoscope ϕ 5.5x280mm
S207-103 Bronchoscope ϕ 5x260mm
S207-104 Bronchoscope ϕ 4x250mm
S207-105 Bronchoscope ϕ 3.5x250mm



Lithotripsy

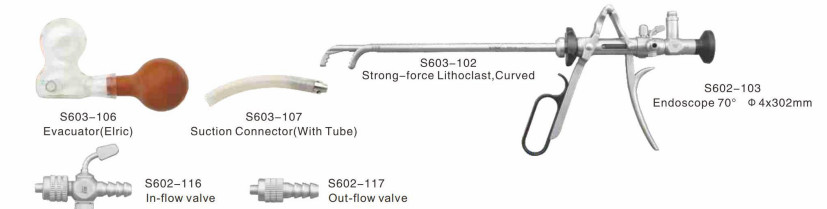

Lithotripsy

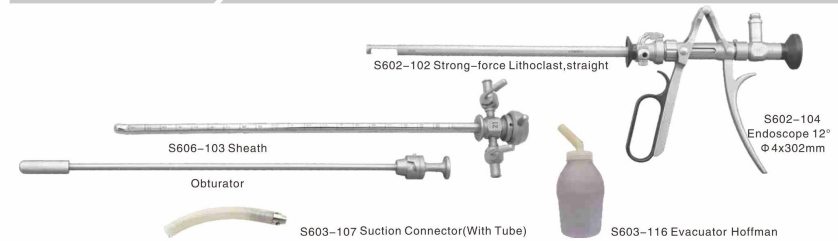

Pelvis Bladder Endoscope

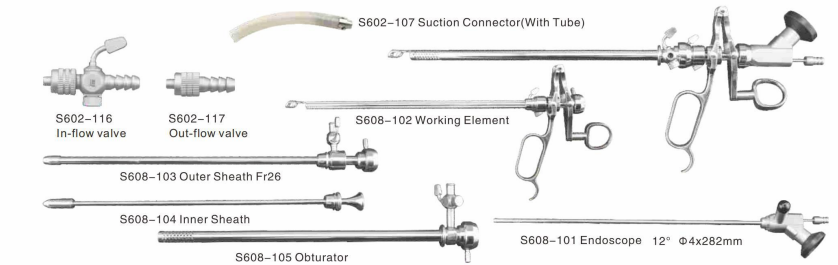

Cystoscope

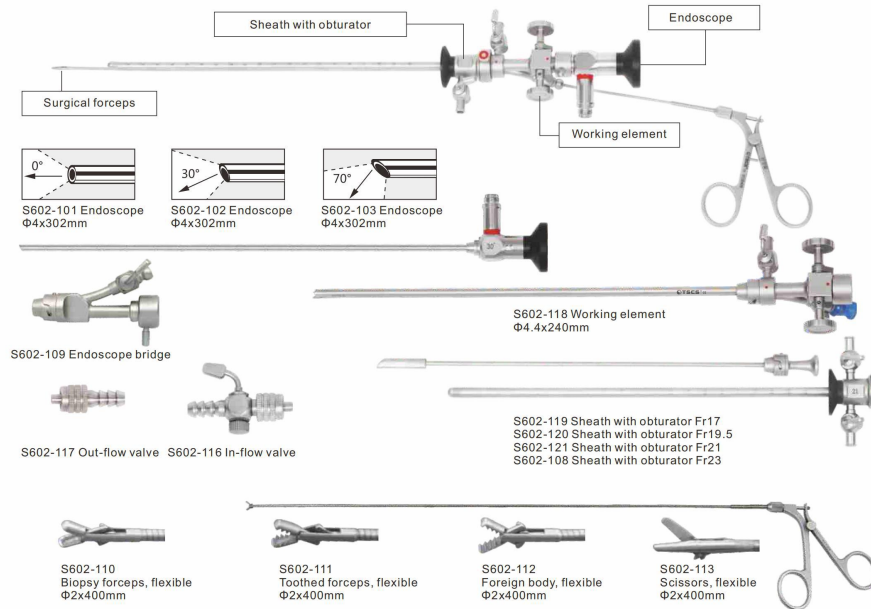

Optional



Resectoscopy(worked with Green Laser)

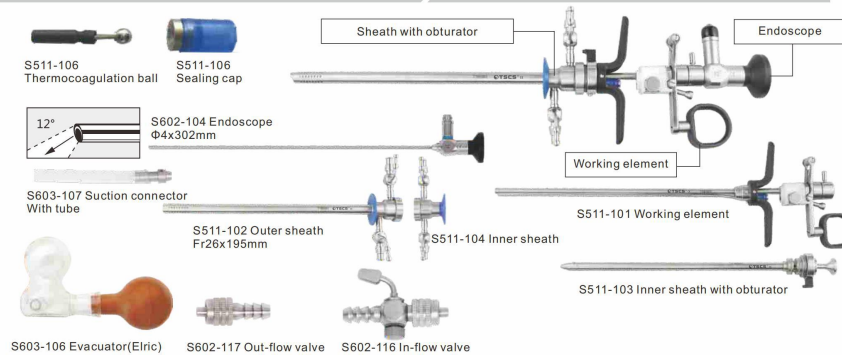

Urethrotomy



Resectoscope

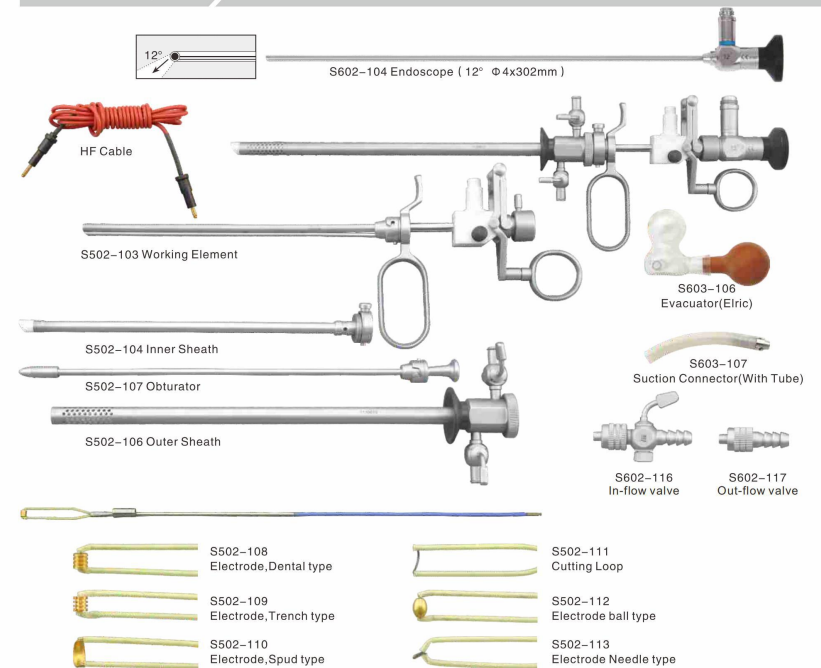

Electrosurgical Unit



S601-102
Electrosurgical Unit

- ★ 400W
- ★ Working Modes and output in every Mode
Cut 5-400W
Falgrate 5-150W
- ★ Bipolar 7-70W
- ★ Voltage: 100-220V 50/60Hz
- ★ Used For Laparoscopy any Resectoscopy

Thyroid Instruments

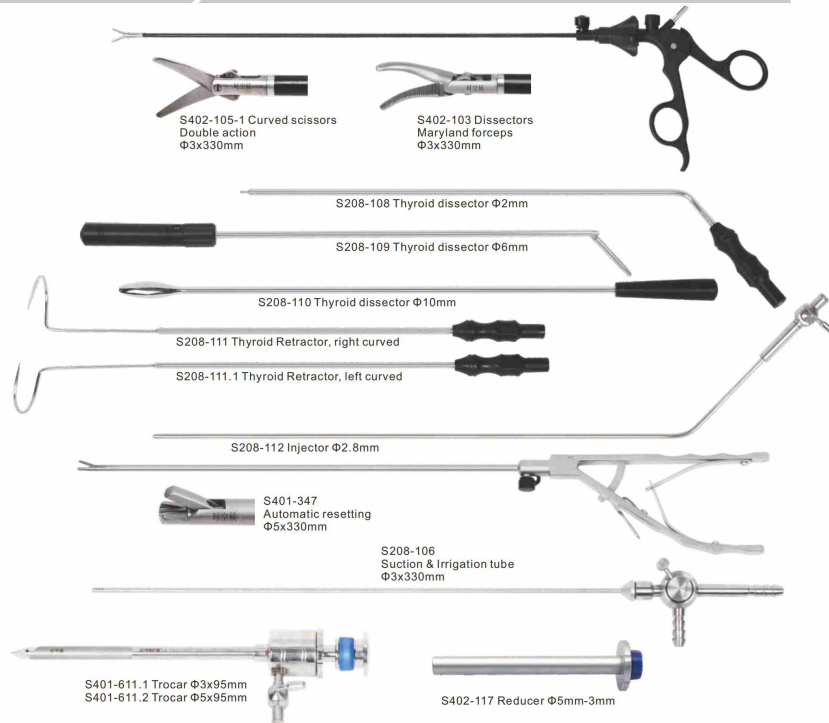

S402-105-1 Curved scissors
Double action
Φ3x330mm

S402-103 Dissectors
Maryland forceps
Φ3x330mm

S208-108 Thyroid dissector Φ2mm

S208-109 Thyroid dissector Φ6mm

S208-110 Thyroid dissector Φ10mm

S208-111 Thyroid Retractor, right curved

S208-111.1 Thyroid Retractor, left curved

S208-112 Injector Φ2.8mm

S401-347
Automatic resetting
Φ5x330mm

S208-106
Suction & Irrigation tube
Φ3x330mm

S401-611.1 Trocar Φ3x95mm
S401-611.2 Trocar Φ5x95mm

S402-117 Reducer Φ5mm-3mm

Arthroscopy Instrument

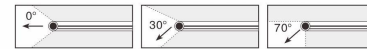

S212-104 Endoscope 0° ,4mm
S212-105 Endoscope 30° ,4mm
S212-106 Endoscope 70° ,4mm

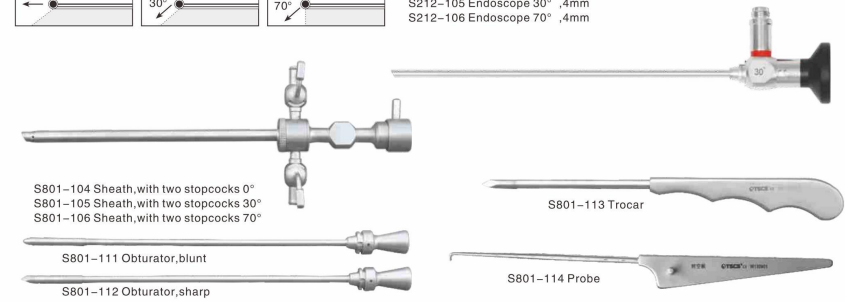

S801-104 Sheath, with two stopcocks 0°
S801-105 Sheath, with two stopcocks 30°
S801-106 Sheath, with two stopcocks 70°

S801-113 Trocar

S801-111 Obturator, blunt

S801-112 Obturator, sharp

S801-114 Probe

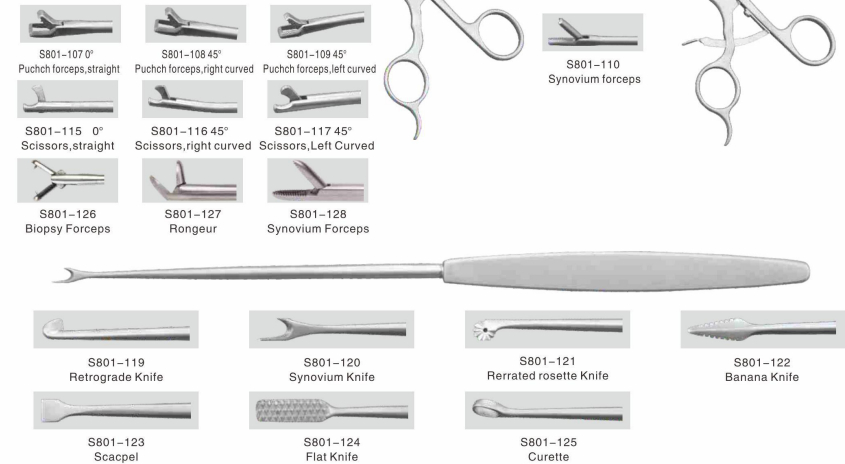

S801-107 0°
Puchch forceps, straight

S801-108 45°
Puchch forceps, right curved

S801-109 45°
Puchch forceps, left curved

S801-110
Synovium forceps

S801-115 0°
Scissors, straight

S801-116 45°
Scissors, right curved

S801-117 45°
Scissors, Left Curved

S801-126
Biopsy Forceps

S801-127
Rongeur

S801-128
Synovium Forceps

S801-119
Retrograde Knife

S801-120
Synovium Knife

S801-121
Rerrated rosette Knife

S801-122
Banana Knife

S801-123
Scapel

S801-124
Flat Knife

S801-125
Curette

Ureterorenoscope



S604-101 Ureterorenoscope Fr7.5

Diskoscope

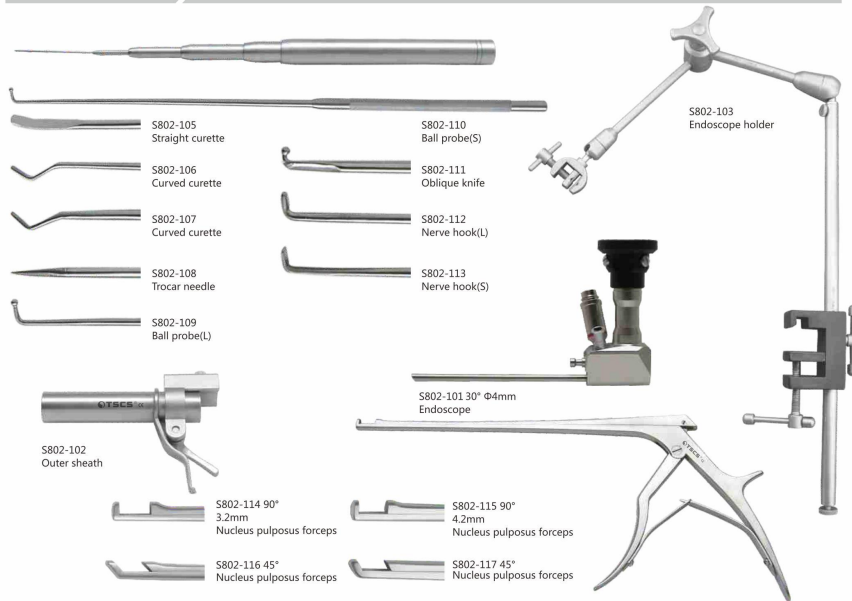

Sigmoidoscope

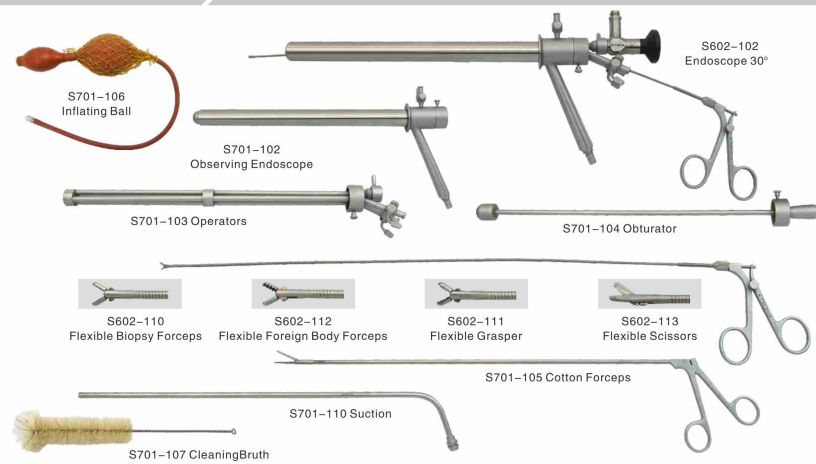

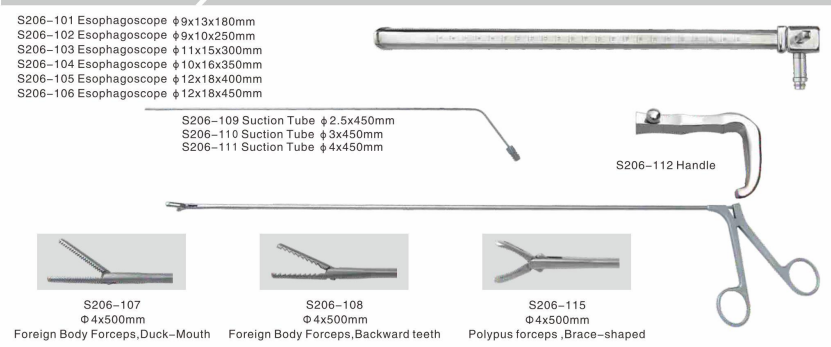

Esophagoscope

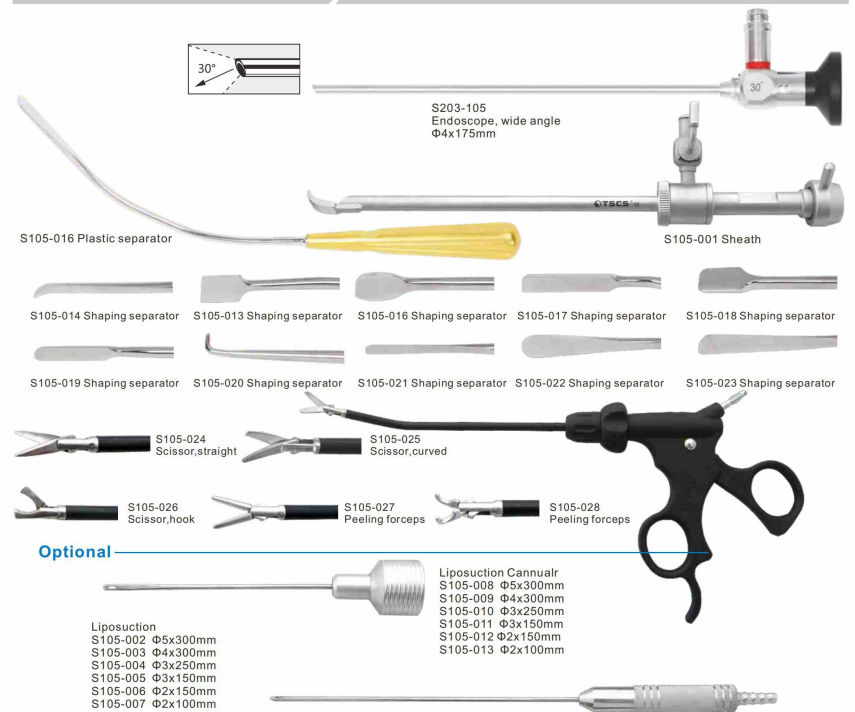

Beauty Surgery Instruments



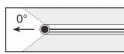

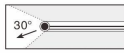

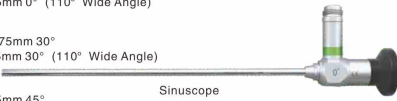
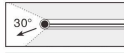
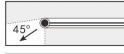
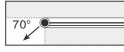

Otoscope

ANGLE	CODE	SPECIFICATION	
	S216-107 S216-101 S212-136	Φ2.7x60mm 0° Φ2.7x108mm 0° Φ4x60mm 0°	 Otoscope
	S216-102 S216-137	Φ2.7x108mm 30° Φ4x60mm 30°	

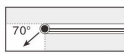

Sinuscope

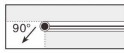
ANGLE	CODE	SPECIFICATION	
	S212-101 S212-104	Φ2.7x175mm 0° Φ4x175mm 0° (110° Wide Angle)	 Sinuscope
	S203-102 S205-105	Φ2.7x175mm 30° Φ4x175mm 30° (110° Wide Angle)	
	S212-107	Φ4x175mm 45°	
	S212-106	Φ4x175mm 70°	

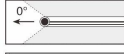
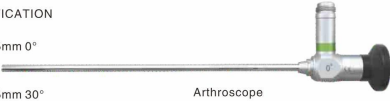

Laryngoscope

ANGLE	CODE	SPECIFICATION	
	S212-223	Φ5x175mm 70°	 Laryngoscope
	S212-222	Φ8x185mm 70°	 Laryngoscope
	S212-221	Φ8x185mm 90°	
	S212-224	Φ4x185mm 12°	 Side View Laryngoscope

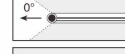

Arthroscope

ANGLE	CODE	SPECIFICATION	
	S212-104	Φ4x175mm 0°	 Arthroscope
	S212-105	Φ4x175mm 30°	
	S212-106	Φ4x175mm 70°	

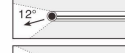
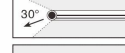
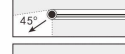
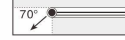



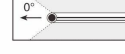
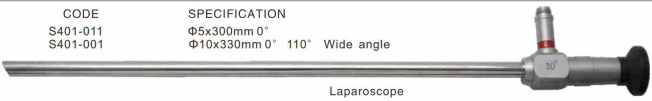

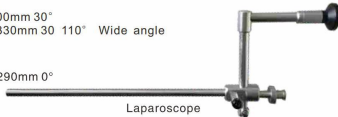
Cystoscope

ANGLE	CODE	SPECIFICATION	
	S603-101 S602-105 S602-101	Φ2.7x302mm 0° Φ2.9x302mm 0° Φ4x302mm 0°	 Cystoscope
	S602-104	Φ4x302mm 12°	
	S602-106 S602-102	Φ2.9x302mm 30° Φ4x302mm 30°	
	S602-107	Φ4x302mm 45°	
	S602-103	Φ4x302mm 70°	

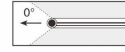
Laparoscope

ANGLE	CODE	SPECIFICATION	
	S401-011 S401-001	Φ5x300mm 0° Φ10x330mm 0° 110° Wide angle	 Laparoscope
	S401-012 S401-002	Φ5x300mm 30° Φ10x330mm 30 110° Wide angle	
	S401-003	Φ10x290mm 0°	 Laparoscope

Hysteroscope

ANGLE	CODE	SPECIFICATION	
	S501-100 S501-111	Φ5.6x200mm 0° Φ6.5x197mm 0°	 Hysteroscope
	S501-099 S501-101	Φ5.6x182mm 22° Φ6.8x188mm 22°	
	S501-103	Φ6.5x195mm 30°	 Hysteroscope
	S602-102	Φ4x302mm 30°	 Hysteroscope

Endoscope Imaging System



HD V230-HD Waterproof camera

- ▶ Resolution: 1920x1080
- ▶ TV System: PAL&NTSC
- ▶ SNR: 54db
- ▶ Video output: S-video, RGB, HDMI
- ▶ White balance: AWC, Menu, Auto Function, Auto Freeze, Zoom, Record
- ▶ With HD video recording

S901-310

120W LED

- ▶ Direct current fan and quite
- ▶ Lamp life \geq 5000 hours
- ▶ 6500k color temp. approx=Natural sunlight
- ▶ Low temperature no infrared ultraviolet rays
- ▶ No high voltage components very safe and efficient environment

S904-103

Suction & Irrigation pump

- ▶ Range of pos-pressure: 10-50kPa
- ▶ Range of neg-pressure: -50-10kPa
- ▶ Maximum liquid volume 5000ml/min
- ▶ Low noise with superior performance, specially filters ensure optimally sterile conditions for minimally invasive surgery
- ▶ Fully automatic, easy intuitive pressure suction and irrigation can be adjusted according to surgery setting

S905-101

Insufflator

- ▶ Fully automatic, quite operation
- ▶ Range of flow: 10-30L, 3level flow rate
- ▶ Automatic safety alarm function
- ▶ Gas supply design for great safety
- ▶ Dual supply filtering and decompression design
- ▶ Range of press: 5-30mmHg

S904-104

Auto Pump

- ▶ Range of Flow: 0.1-1.0L/min
- ▶ Range of press: 10-400mmHg
- ▶ High sensitivity pressure sensor
- ▶ Emulsion tube and shim are replaceable
- ▶ Used in arthroscopy, hysteroscopy and urology surgeries
- ▶ Sterile tubing sets with sensor, a peristaltic pump and two channels

S905-102

Portable LED Light Source

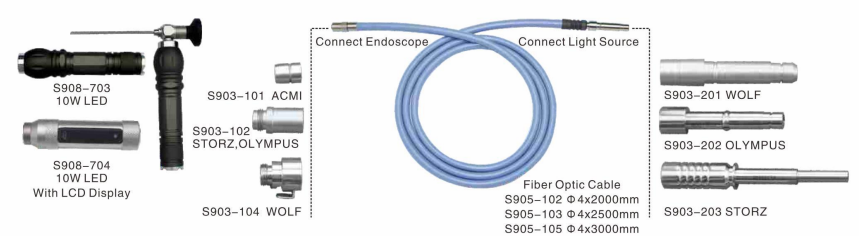

Connect Endoscope Connect Light Source

S908-703 10W LED
S908-704 10W LED With LCD Display

S903-101 ACMI
S903-102 STORZ, OLYMPUS
S903-104 WOLF

Fiber Optic Cable
S905-102 Φ 4x2000mm
S905-103 Φ 4x2500mm
S905-105 Φ 4x3000mm

S903-201 WOLF
S903-202 OLYMPUS
S903-203 STORZ

Valve

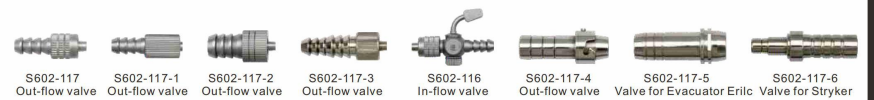

S602-117 Out-flow valve S602-117-1 Out-flow valve S602-117-2 Out-flow valve S602-117-3 Out-flow valve S602-116 In-flow valve S602-117-4 Out-flow valve S602-117-5 Valve for Evacuator Eric S602-117-6 Valve for Stryker

Accessories



Laparoscopic Trainer

Product Name	Order Code	Specification
Coupler	S901-301-1	F14
	S901-301-2	F18
	S901-301-3	F20
	S901-301-4	F22
	S901-301-5	F25
	S901-301-6	F28
	S901-301-7	F32
	S901-301-8	F35
Coupler zoom in	S901-301-9	F18-F35

S911-107 540x230x70mm Sterilization box S911-108 550x250x100mm Sterilization box

S911-109 440x84x42mm Sterilization box for laparoscope

S911-110 420x280x90mm Sterilization box for electrotyomy S911-111 270x84x42mm Sterilization box for ENT

S911-105 525x300x155mm Sterilization box for laparoscopic S911-106 540x250x135mm Sterilization box for Morcellator